

POS 2

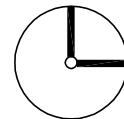

CIRCUIT: SPDT  
CONTACT CONFIGURATION

SWITCH FUNCTION	
POS 1	POS 2
↑	→
ON	ON

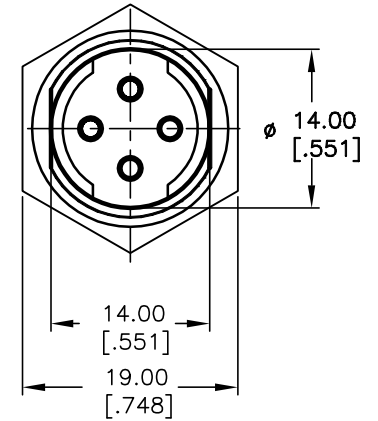
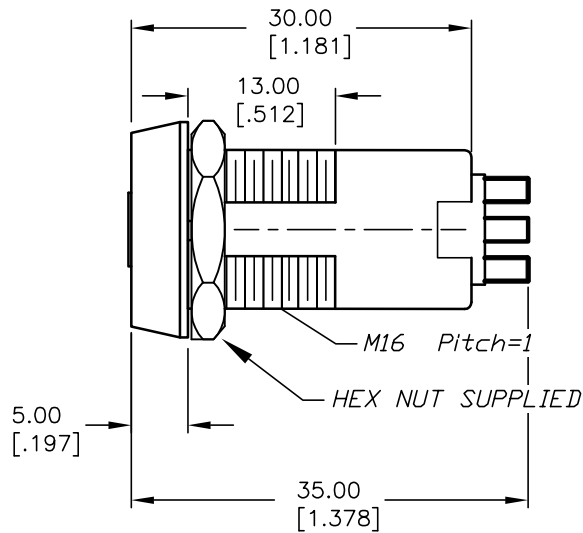
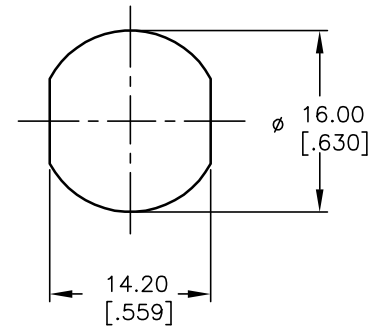

RECOMMENDED PANEL CUTOUT

LEGEND

- =INDICATES KEY PULL
- X =INDICATES NO KEY PULL

NOTES:

1. ALL DIMENSIONS IN MM [INCH]
2. GENERAL TOLERANCE: X.X=±0.4  
X.XX=±0.25
3. TERM. NOS. FOR REFERENCE ONLY.
4. RATING: 3A @125VAC, 1.5A @250VAC
5. CONTACT RESISTANCE: 10mILLI-OHMS
6. DIELECTRIC STRENGTH: 1000 VAC-1Minute
7. INSULATION RESISTANCE: 200 Mega-OHMS min.
8. MATERIALS:

HOUSING: ZINC ALLOY DIE CAST  
CYLINDER: ZINC ALLOY W/CHROME PLATING  
TERMINAL AND CONTACTS: SILVER PLATED  
KEYS (2) KEY CODE 10002: TUBULAR  
ZINC ALLOY, CHROME PLATING W/PLASTIC COVER

**E-SWITCH®**

TITLE					K□104B-10008				
SCALE	DATE	DR	DWG	REV	SCALE	DATE	DR	DWG	REV
1.5:1	2/4/04	AR	K300109	A					

A	13572	RELEASED FOR PRODUCTION	2/4/04	AR
REV.	ECN No.	DESCRIPTION	DATE	CHKD

THE INFORMATION CONTAINED IN THIS DOCUMENT IS PROPRIETARY TO E-SWITCH AND IS NOT TO BE COPIED OR TRANSFERRED